

BioSure

PROFESSIONAL

WDS | WDS3000X

WATER DISINFECTION SYSTEM

Model EOS7177-PQX

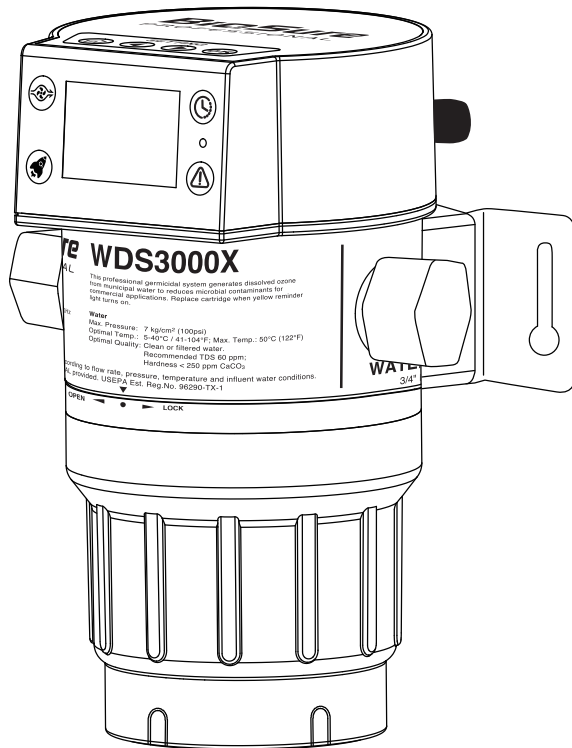

INSTALLATION & OPERATION MANUAL

PREFACE

Thank you for choosing BioSure Professional equipment. This manual contains basic installation, operation and maintenance instructions for BioSure Professional WDS Series, including WDS and WDS3000X.

BioSure Professional is a division of Biotek Environmental Science Ltd. ("BES Group"). BES Group is a global leading electrolytic technology developer and product manufacturer with pioneering ozone application knowledge and currently holds many exclusive patents for its electrolytic ozone generators and products worldwide.

COPYRIGHT

©2021 Biotek Environmental Science Ltd. (BES Group)

All Rights Reserved.

Reproduction, adaptation, or translation without prior written permission is prohibited, except as allowed under the copyright laws.

REV.: 2022.12

DISCLAMATION

The information contained in this document is subject to change without notice.

BES Group shall not be liable for any direct, indirect, incidental, consequential, or other damage alleged in connection with the furnishing or use of this information. BES Group is not liable for damages on any contact materials due to result of oxidation.

BES Group makes no warranty of any kind with respect to this information. BES GROUP SPECIFICALLY DISCLAIMS THE IMPLIED WARRANTY OF MERCHANTABILITY AND FITNESS FOR A PARTICULAR PURPOSE.

TABLE OF CONTENTS

TABLE OF CONTENTS	1
PACKAGING CONTENTS	2
IMPORTANT SAFETY INFORMATION	3
1. PRODUCT INFORMATION	7
1.1 PRODUCT DESCRIPTION	7
1.2 KEY COMPONENTS	7
1.3 SPECIFICATIONS	8
2. INSTALLATION	9
2.1 PRECAUTIONS BEFORE INSTALLATION	9
2.2 INSTALLING THE UNIT	11
2.3 TO REMOVE THE UNIT	13
3. OPERATION	14
3.1 CONTROL KEYS & INDICATORS	14
3.2 OPERATION MENU	15
3.3 OPERATION SETTINGS & STATUS	17
3.4 SYSTEM CONFIGURATION GUIDES	22
4. MAINTENANCE	23
4.1 EXPECTED CELL CARTRIDGE LIFE	23
4.2 CELL CARTRIDGE REPLACEMENT	23
4.3 CELL CARTRIDGE CLEANING PROCEDURE	25
5. TROUBLESHOOTING	26
6. WARRANTY INFORMATION	28

PACKAGING CONTENTS



Owner's Manual

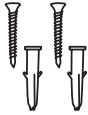

Wall-Mount Phillips
Screws (x2)
&
Plastic Drywall Wall
Anchors (x2)



Plumber's Tape (x1)

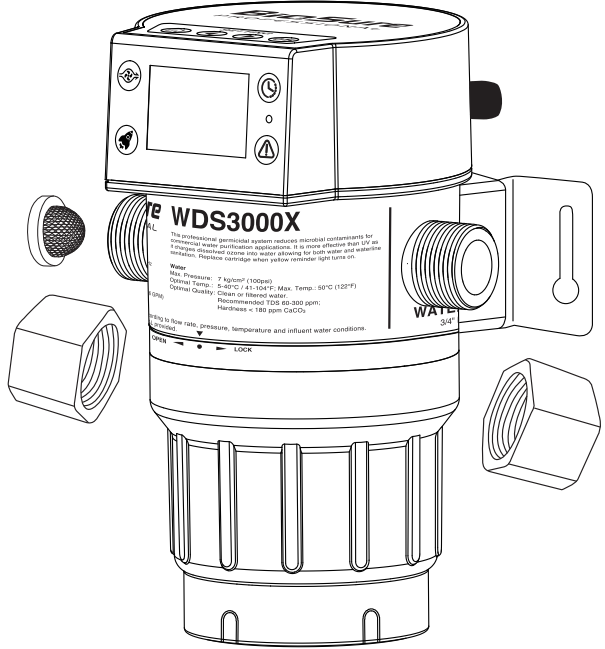

Main Device

[attachments include Ozone Generator
Cartridge (x1) and Connector Caps (x4)
and Inlet Screen Filter (x1)]

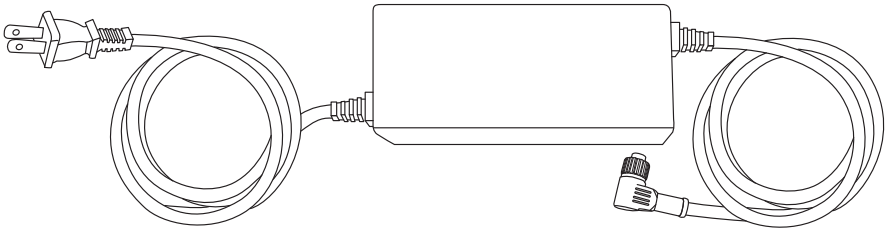

Power Supply Adaptor

IMPORTANT SAFETY INFORMATION

This manual contains basic installation, operation and maintenance instructions for BioSure Professional Electrolytic Ozone Water Disinfection System, WDS and WDS3000X Series. For additional guidance, consult BES Group BioSure Professional Customer Service or your local authorized dealer.

Attention Installer: This manual contains important information about the installation, operation and safe usage of this product. This information should be given to the owner and/or operator of this equipment after installation.

Attention User: This manual contains important information that will help you in operating and maintaining this unit. Please save these instructions for future reference.

In order to prevent accidents or injuries to the installer, user, other people, and damage to property, please follow these safety instructions below :

Explanation of Safety and Notice Symbols

 **WARNING** WARNING indicates a hazardous situation which, if not avoided, **COULD** result in death or serious injury.

 **CAUTION** CAUTION indicates a hazardous situation which, if not avoided, **COULD** result in injury or property damage.

 **NOTICE** NOTICE is used to address practice that is required and must be followed.

----- **READ AND SAVE THESE INSTRUCTIONS** -----

Electrical Safety and Basic Safeguards

- All service work must be performed by a qualified and authorized technician. NEVER attempt to disassemble, repair, or remodel the unit yourself. Doing so will void your warranty and can lead to fire or electric shock. If the product malfunctions or has been damaged in any manner, unplug the unit and contact the BioSure Professional service department or its authorized local service agent or dealer to arrange service or repair.
- Do NOT damage the Power Supply and Power Plug Cord. A damaged Power Supply or Power Plug Cord can cause fire or electric shock.
 - Never stretch, bend, pull, twist, fold, tie or attempt to modify the power cord or power plug.
 - When unplugging, pull by the molded part of power plug.

- Do NOT use or operate the unit with a damaged Power Supply or Power Plug. If the Power Supply or Power Plug Cord is damaged, it must be replaced by the manufacturer, authorized service agent, dealer, or similarly qualified person in order to avoid hazard. Component must be replaced using appropriate cord or assembly made available by the manufacturer or authorized service agent or dealer.
- Do NOT use in a manner that exceeds the rating of the power outlet or connected equipment. Plugging too many devices into the same outlet may cause the electrical outlet to overheat and result in a fire.
- Do NOT use a power supply voltage other than being specified on the product and the power supply. Use of any other power supply voltage may cause a fire or electric shock.
- To prevent accidental shock, we recommend this product always be used on a GFCI (Ground Fault Circuit Interrupter) outlet.

 **WARNING**

- Do NOT plug or unplug the Power Supply or Power Plug if your hands are wet. Doing so can cause electric shock or injury.
- Do NOT use the product if the power plug is loosely inserted into the electrical outlet. A loosely inserted power plug may cause a fire, electric shock or short circuit. Before using, make sure the Power Plug are inserted into the electrical outlet completely and securely.
- If the blades or surface of the power plug become soiled, wipe them clean before using. A dirty power plug may cause a fire.
- Keep the product and power cord away from heated or hot surfaces including space heaters, stoves, and similar electrical appliances.
- Do NOT put the machine in water or spray water onto it. Otherwise it may damage the unit or cause electric shock.
- To safeguard against fire, electric shock and possible injury risks, keep the power cord, power plug and the product away from water or other liquids.
- Stop using the product immediately if you notice any of the following symptoms indicating abnormality or malfunction:
 - The Power Supply or Power Plug Cord is damaged.
 - The Power Supply or Power Plug Cord becomes very hot.
 - The Body of product is abnormally hot or deformed.
 - Smoke coming from the product or there is burning smell.
 - Some part of the product is cracked, loose, or unstable.

- If any of the above issues occur, unplug the product immediately and return to authorized agent or dealer for service and repair. Continued use of the product may cause a fire, electric shock, or injury.

CAUTION

- All permanent electrical connections should be made by a qualified electrician. Follow all applicable electrical codes.
- All plumbing or connections should be completely set up before plugging power to power on. Ensure the water output is properly connected to a correctly determined corresponding position.
- To maintain cosmetic integrity, protect this unit from direct prolonged sunlight exposure.
- For your safety, DO NOT operate the device with any panels or covers removed.
- The system should be sized appropriately for its intended use by a qualified professional familiar with the application.
- Ensure power and water supply meet requirements as indicated in the product specifications. Failure to install, operate and maintain this device as instructed could void warranty and result in injury or product damage.

NOTICE

- **A short Power Cord is provided for your safety. To reduce risks from entanglement or tripping, using longer Power Cord is not recommended. Extension cord should only be used if care is exercised.**
- **In cases If extension cord is used:**
 - The marked electrical rating of the extension cord should be at least as high as the electrical rating of the product.
 - The extension cord should have a ground-type 3-pronged plug.
 - The extension cord should not drape over the countertop or tabletop where it can cause tripping over the cord.

Specific Safety Information

For your own personal safety and to prevent accidental damage to the product, please ensure that you read and understand this Manual.

- ALWAYS ensure all electrical circuits are disconnected before performing service, maintenance, or installation work.

- ALWAYS ensure all factory installed parts and components are re-installed properly and are in good condition after performing service, maintenance, or installation work.
- NEVER use inappropriate tools, processes, or procedures. Damage to components of device can occur.
- NEVER discard any loose parts received with device. They may be required for proper and safe installation and operation.
- Keep away from any open fire (>100cm)
- Never attempt any servicing while unit is wet. Be sure to turn power OFF and disconnect from power source before any service work is performed. Failure to do so could result in serious injury or death.
- Ensure power and water supply meet requirements as indicated in the product specifications. Failure to install, operate and maintain this device as instructed could void warranty and result in injury or product damage.

1.1 PRODUCT DESCRIPTION

BioSure Professional WDS and WDS3000X Series are automatic germicidal systems designed to reduce microbial contaminants for water purification applications. These can include post-filtration water and waterlines sanitation treatment, which removes or reduces unwanted microbial contaminants in filtered water and biofilm in waterlines, or alternatively providing ozonated sanitizing water for sanitation use, depending on the way of installation and configuration. The system applies a revolutionary advanced electrolytic ozone technology, which features on-demand contribution of reliable sanitizing benefits of dissolved ozone in effective and safe manners in water dispensing and treatment applications.

1.2 KEY COMPONENTS

Head	Item	Part Name
	1	Water Inlet (3/4" NPT)
	2	Water Outlet (3/4" NPT)
	3	Cell Cartridge Power Socket (for cell cartridge connection)
	4	Main Power Socket (for power supply connection)
	5	Control Keys Panel

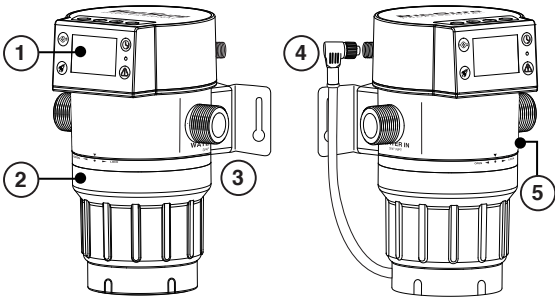
Overall	Item	Part Name
	1	Display Panel
	2	Replaceable cell cartridge
	3	Mounting Bracket
	4	Cell Cartridge Power Plug
	5	Placard

1.3 SPECIFICATIONS

Our electrolytic ozone generator incorporates a scale-preventing feature that automatically operates polarity reversal to prevent mineral buildup on the electrodes, ensuring optimal ozone generation performance.

Model		EOS7177-PQX
OZONE PRODUCTION		300 mg/hr (±10%) at 20°C (TDS 60 ppm)
WATER SUPPLY	Quality	Clean or filtered water. (Recommendation: filtered to 1µm, TDS > 60 ppm, Hardness < 250 ppm as CaCO ₃)
	Flow	Min. 60 LPH (0.26 GPM) Max. 2300 LPH (10.0 GPM)
	Pressure	Min. 0.5 kg/cm ² (8 psi) Max. 7.0 kg/cm ² (100 psi)
	Optimal Temp.	5°C - 40°C / 41°F - 104°F Max.Temp.: 50°C (122°F)
ELECTRICAL	Power	Adaptor Input : AC 100-240V, 50/60Hz Adaptor Output : DC 24V, 4A
	Rate	96W
AMBIENT AIR	Temp.	> 0°C - 40°C (> 32°F - 104°F)
	Humidity	0 - 90% non-condensing humidity
DIMENSIONS	W x D x H	140 x 128.5 x 210.5 mm (5.51" x 5.06" x 8.23")
WEIGHT	Net	1.3 Kg (2.9 lbs)
	Filled	1.8 Kg (4.0 lbs)
IP CLASS		IP55
CONNECTIONS		3/4" NPT Water Inlet & Outlet

Certification: 

2.1. PRECAUTIONS BEFORE INSTALLATION

**If any parts are damaged, contact your supplier IMMEDIATELY.
Do NOT install damaged parts.**

This device is designed and engineered for easy integration into existing water systems. However, having the following tools and supplies in hand will be greatly helpful to the installation:

- Screwdriver
- Drill bit
- Tape measure
- Pipe wrench
- Adjustable wrench

Electrical

Ensure that the line voltage corresponds to the stated voltage on the unit's specification label. Make sure that the plug on the power cord from the product and the outlet are matched. For proper operation, and to ensure the best performance of application from the product, make sure that the system is not connected to a switched electrical outlet.

Plumbing

- For best performance, use cold tap water and filter the input water to 1 μ m.
- For safety, run water pressure under 7 kg/cm² (100 psi). To reduce water pressure, install a water pressure regulator and set water pressure to suit application.
- Ensure adequate back-flow protection is provided to comply with all national and local standards and codes.
- Do NOT over-tighten the connections. It is recommended that plastic fittings be used when connecting to the plastic connections of the product. This will reduce the possibility of cracking the connections due to over-tightening. The use of union (O-ring seal) connections is highly recommended for ease of installation and future servicing.

Other Important Information

Observe these guidelines to ensure optimal device functions and performances.

1. Select a location for the unit so:

- Mount the system after all water filtration processes.
- Mount the system near but NOT above an electrical outlet.
- It will be in an upright position.

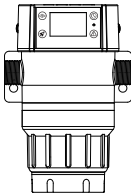

UPRIGHT
POSITION

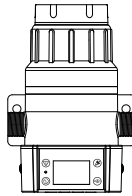

INVERTED
POSITION

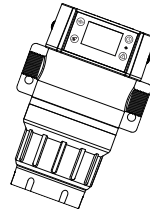

SIDWAYS
POSITION

- LED lights and cartridge are visible and accessible. Allow sufficient access for cartridge replacement. Recommended minimum "Vertical Clearance" is 30cm (12").
- It is highly recommended that a water shut-off valve be installed before and near the WDS unit.
- Other equipment or objects should not lean on or press against the device.

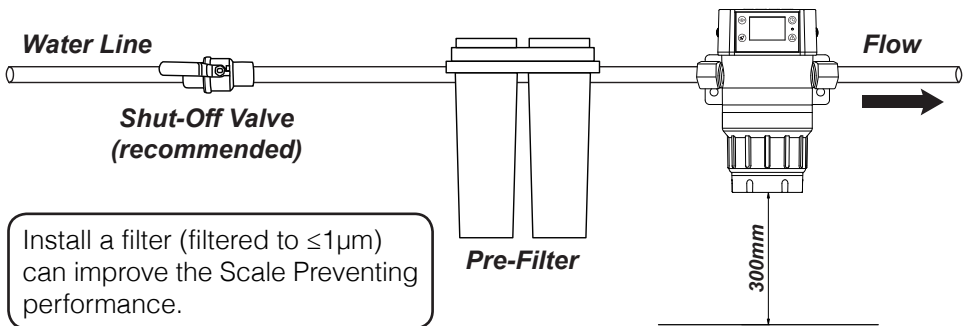

2. Do NOT mount the system above any electrical equipment or items that may be damaged if they get wet.
3. Note the existing waterline piping layout and flow direction when connecting appropriate size of tubing on the "WATER IN" and "WATER OUT" sides of the unit.
4. For best result, clean and sanitize the connecting waterlines thoroughly before installing.

2.2. INSTALLING THE UNIT

• STEP 1. Connecting Cell Cartridge Power

Connect the Cell Cartridge Power Plug to the Cell Cartridge Power Socket on the Head.

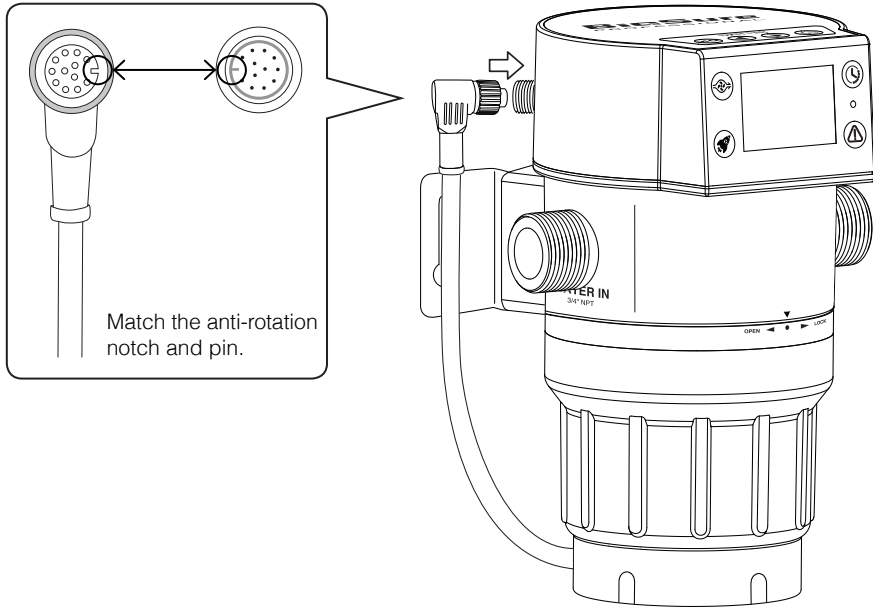

• STEP 2. Mounting the Unit

The unit is pre-assembled to a Mounting Bracket. The Mounting Bracket has mounting holes to secure the body of the unit to a wall. Please follow the previous section "Precautions before installation" to select an appropriate location and mark it. Secure the Mounting Bracket into wall studs or with the appropriate heavy-duty mounting hardware.

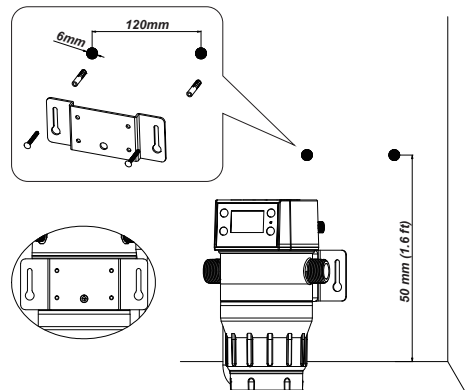

! NOTICE

PLUMBING NOTE

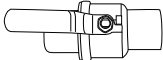
1. Before connecting the fitting to the System Inlet, the plumbing to the unit must be flushed clear of all debris.
2. Install the inlet screen filter (attachment) on the water inlet of the unit. Note the flow direction. Connect appropriate size of tubing on the "WATER IN" and "WATER OUT" sides of the unit. 
3. When making a plumbing connection to the product, always use a good quality, approved pipe sealant or thread seal tape on pipe threads. Be careful not to get the pipe sealant inside the pipe when making the connections.
4. A shut-off valve (not supplied) should be installed in the line leading to the product as inlet water valve. The valve should be mounted close to the system inlet and sized properly for the inlet plumbing line. This valve will allow for the following two functions:
 - Easier servicing and future cell cartridge replacement.
 - Configuring flow as well as dissolved ozone concentrations.

Shut-off Valve
5. Use 3/4" fitting for "WATER IN" and "WATER OUT" connections. Connecting smaller diameter tubing will increase dynamic flow loss in the output performance.

• STEP 3. Starting the Unit

There is no ON/OFF control switch with the unit. The unit is switched ON by connecting the power supply cord into a wall electrical outlet (power supply).

1. Connect the Power Supply Cord into the Main Power Socket (marked as "Power") at rear left to the Head. Here is the design to guide plug in properly.

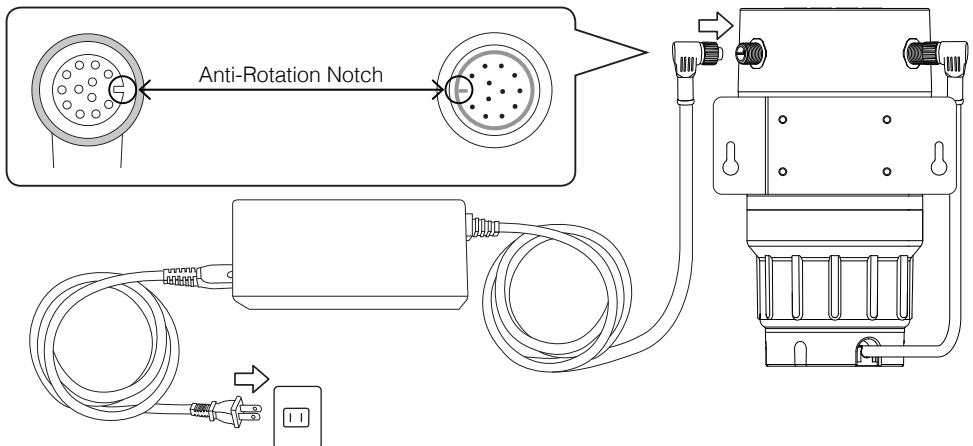

2. Plug the Power Adapter into the wall electricity outlet.
3. The Screen and LEDs on the controller (the Head) will light up, indicating the unit has power.

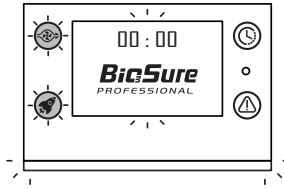

! NOTICE

Before connecting the unit to power supply, ensure all plumbing connections are secure and leak-free, from shut-off valve to outlet.

2.3. TO REMOVE THE UNIT

Please follow descriptions below :

1. Disconnect the power.
2. Shut off the Shut-off valve before the unit.
3. Open the faucet or tap closest downstream to the device.
4. Loosen the connectors of water inlet and outlet.
5. Take off the unit. Use proper tools if necessary.
6. Restore water line.

※: You may tilt the body slightly to drain the remaining water in the unit from the water outlet.

3.1 CONTROL KEYS & INDICATORS

Control Keys

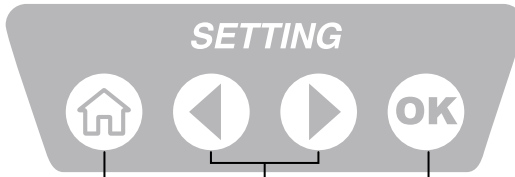

Menu / Return

- Enter or return to Menu as ESC

Selections

- Display alternatives
- Select settings

OK / Enter

- Save selection
- Confirm selection

Indicators

Flow-Starting indicator

Blue LED
Flow switch activated - the unit is under flow-starting operation.

Dosage level indicator

Blue LED
100% dissolved ozone performance.
(50% as standard when off).

Flow indicator

Blue LED Bar
Steady solid on - water flow detected.
Blue breathing - standby, no flow detected and the light will extinguish after 3 minutes.

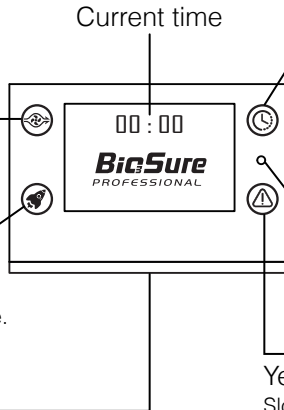

Timer-Controlling indicator

Blue LED
Timer switch activated - the unit is under timer-controlling operation.

Operation indicator

Green LED
Dissolved ozone dosage is activated.

Alarm indicator

Yellow LED

Slow blinking - system error detected in POST (Power On Self Testing).
Fast blinking - system error detected while the unit is on duty.
Steady solid on - replace cell cartridge now.
※: For detail regarding all error codes, refer to Troubleshooting in Section 5.

3.2 OPERATION MENU

Menu Operating Principle

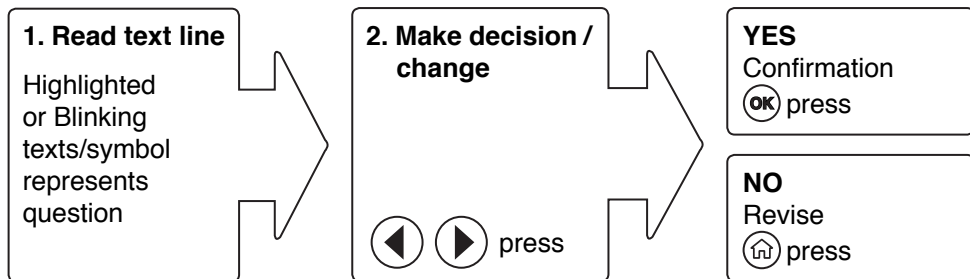

Menu Overview

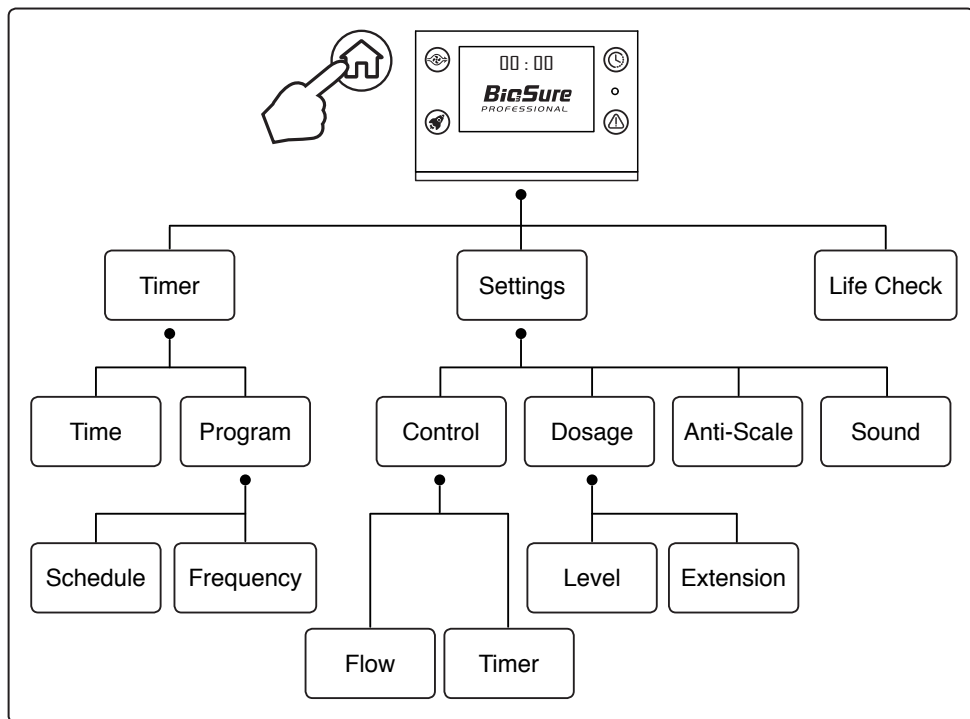

Timer

Time Setup or change current time

Program Program switching schedule and frequency settings

- **Schedule** Activation schedule for hourly basis (00-23 on the hour). Default is 00-23 all on.

- **Frequency** Program switching frequency in scheduled operating hour.

Factory default setting is 60-second dosage in 3-minute cycle. User can configure the frequency by selecting the "configuration" option:

- **Interval** - User can set the interval cycle from 3 to 60 minutes (in units of 3 minutes).
 - **Period** - User can set the range from 10 to 60 seconds (10 seconds as a unit) for ozone dosage in each interval cycle.
-

Settings

Control Select switching controllers: flow-starting, or timer-controlling (default is flow-starting).

Dosage

- **Level** Select dosing levels: standard or boost with 50% increase (default is boost).

- **Extension** You can extend ozone generation time after each usage to raise ozone concentration in advance for the next use. Options include:

1. None (default)
2. 60-second extension
3. 120-second extension

Anti-Scale Select settings for auto-descaling and self-cleaning function according to the running water quality in terms of Total Dissolved Solids (TDS) level. Options include:

1. TDS < 100 (default)
2. TDS > 100

Sound Set the alarm on or off (default is off). With the function on, the unit will beep 3 times when:

1. the "Sound" function is activated successfully
 2. the system shows alarm message
 3. the life of cell cartridge expires. (The unit will beep 3 times whenever the cell cartridge works after the first warning)
-

Life Check Check the remaining life of cell cartridge, expressed in percentage (%)

! NOTICE

The configured "Program" ONLY functions when the use of "Timer-Controlling" is selected.

The configured "Extension" ONLY functions when the use of "Flow-Starting" is selected.

3.3 OPERATION SETTINGS & STATUS

Setting Current Time

Step 1. Enter MENU and then select Timer



- ▶ Press **MENU** (⏠) .
- ▶ Use (◀) (▶) to select **Timer** and confirm with (OK) .

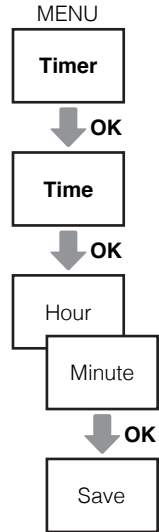

Step 2. Select Time to set Hour and Minute

- ▶ Operate (◀) (▶) to select **Time** and confirm with (OK) .
- ▶ To switch setting between Hour and Minute use (▶) .
- ▶ To adjust Hour (1-12) or Minute (1-59) press (◀) .
- ▶ Confirm with (OK) .

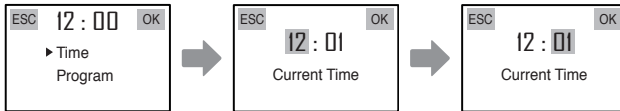

Configuring Alarm

(Default: OFF)

Step 1. Enter MENU and then select Settings

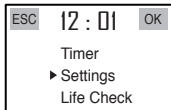

- ▶ Press **MENU** (⏠) .
- ▶ Use (◀) (▶) to select **Settings** and confirm with (OK) .

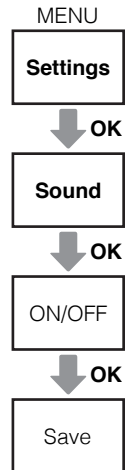

Step 2. Select Sound and follow on-screen options to select Sound ON or Sound OFF

- ▶ Operate (◀) (▶) to select **Sound** and confirm with (OK) .
- ▶ To select ON or OFF from on-screen options use (◀) (▶) .
- ▶ Confirm with (OK) .

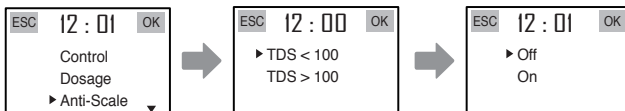

Configuring Dosing Level

(Default: Boost)

Step 1. Enter MENU and then select Settings

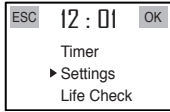



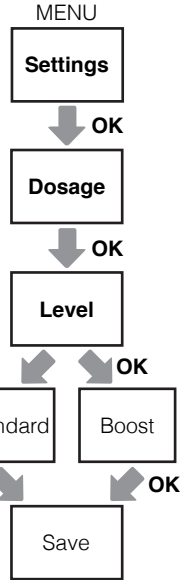





- ▶ Press **MENU** .
- ▶ Use   to select **Settings** and confirm with .



Step 2. Select Dosage and then select Level.

Follow on-screen options to select desired setting

- ▶ Use   to select **Dosage** and confirm with .
- ▶ Operate   to select **Level** and confirm with .
- ▶ To select "Standard" or "Boost" from on-screen options use  .
- ▶ Confirm with .

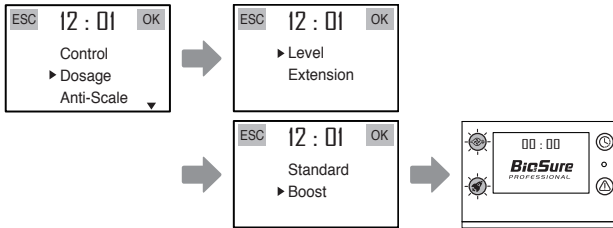

! NOTICE

When **Standard** is selected, the cell cartridge output is at 50% reduced to provide a lower dosage of dissolved ozone. When **Boost** is selected, the output of the cell cartridge will increase by 50% from standard to reach the maximum performance. Switching between standard and boost will not affect the cartridge's performance life.

Configuring Anti-Scale Settings





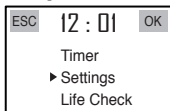

(Default: TDS < 100)

Step 1. Enter MENU and then select Settings



- ▶ Press **MENU** .
- ▶ Use   to select **Settings** and confirm with .

Step 2. Select Anti-Scale and then follow the on-screen options to select settings according to the TDS quality of the water used.

- ▶ Operate   to select **Anti-Scale** and confirm with .
- ▶ Use   to select TDS < 100 or TDS > 100 according to the actual water quality.
- ▶ Confirm with .

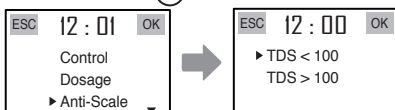
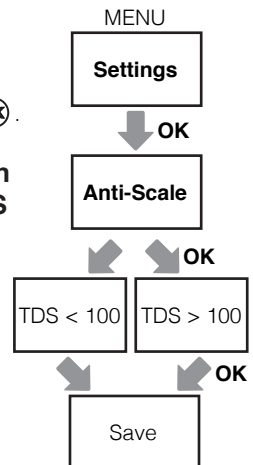

Configuring Controls

(Default: Flow)

Step 1. Enter MENU and then select Settings

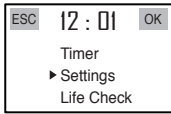

- ▶ Press **MENU** (M) .
- ▶ Use (Left) (Right) to select **Settings** and confirm with (OK) .

Step 2. Select Control and follow on-screen options to select desired setting

- ▶ Use (Left) (Right) to select **Control** and confirm with (OK) .
- ▶ To select **Flow** or **Timer** from on-screen options use (Left) (Right) .
- ▶ Confirm with (OK) .

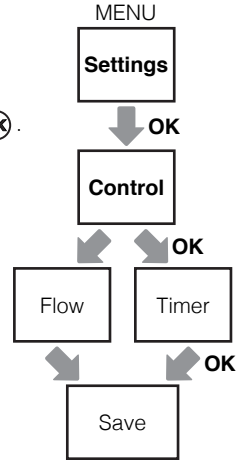
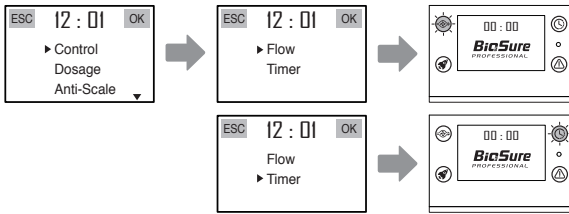

! NOTICE

When **Flow** is selected, the unit is triggered to start and operate continuously as long as a flow >60LPH (0.26 GPM) is provided and maintained.

When **Timer** is selected, the unit generates ozone according to the set schedule and frequency (the set program), following the set current local time. The unit will always start precisely on the hour according to the programmed schedule, and the generation will line up to the programmed frequency. However, between two adjacent generations, there must exist a > 1 second and > 60LPH (0.26 GPM) flow. The flow is necessary for the unit to continue the operation preventing pressure build-up within the cartridge. If this check flow is delayed, the next generation will be postponed to the next available frequency point after the detected check flow.

Configuring Programs

Programming a work schedule and operating frequency in timer-controlling scheme.
Before doing this, please make sure to set the current time correctly in the "time" option.

① Setting schedule

Hourly activating schedule (00-23 on the hour).

Step 1. Enter MENU and then select Timer



- ▶ Press **MENU** (Fn) .
- ▶ Use (Left) (Right) to select **Timer** and confirm with (OK) .

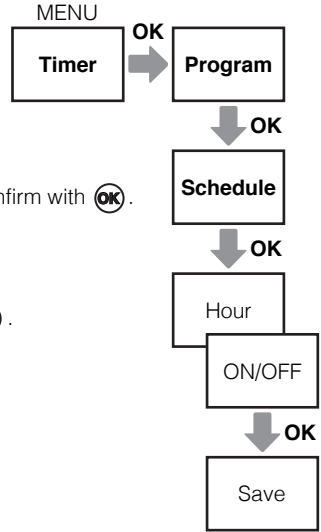

Step 2. Enter Program and then select Schedule

- ▶ Operate (Left) (Right) to select **Program** and confirm with (OK) .
- ▶ Use (Left) (Right) to select **Schedule** and confirm with (OK) .



Step 3. Set Schedule (Default: all ON)

- ▶ To switch setting among 24 hours (00-23) use (Left) .
- ▶ To switch ON or OFF for desired set hour use (Right) .
- ▶ Confirm with (OK) .

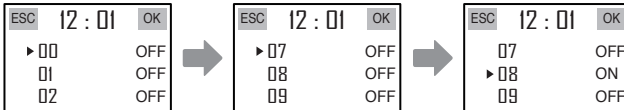

② Setting Frequency (Default: 60 sec / 3 min)

Program switching frequency in scheduled operating hour.

Step 1. Enter MENU and then select Timer



- ▶ Press **MENU** (Fn) .
- ▶ Use (Left) (Right) to select **Timer** and confirm with (OK) .

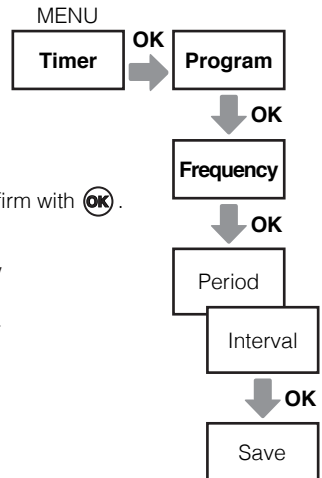

Step 2. Enter Program and then select Frequency

- ▶ Operate (Left) (Right) to select **Program** and confirm with (OK) .
- ▶ Use (Left) (Right) to select **Frequency** and confirm with (OK) .



Configuring Programs

Step 3. Set Frequency

Default frequency setting is 60s/3m. Select Configuration and user can change the setting based on application and needs.

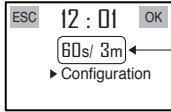

Display of current frequency setting

- ▶ Select "**Configuration**", there are two parameters need to be set: Ozone dosage (Period) and Cycle interval (Interval)

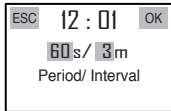

- ▶ To switch setting between **Period** and **Interval** use .
- ▶ To adjust **Period** (0-60 sec) or **Interval** (0-60min) press .
- ▶ Confirm with .

Configuring Extension

(Default: None)

Step 1. Enter MENU and then select Settings

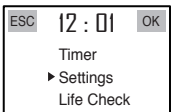

- ▶ Press **MENU** .
- ▶ Use to select **Settings** and confirm with .

Step 2. Select Dosage and then select Extension. Follow on-screen options to select desired setting

- ▶ Operate to select **Dosage** and confirm with .
- ▶ Use to select **Extension** and confirm with .
- ▶ To select extension period from on-screen options use .
- ▶ Confirm with .

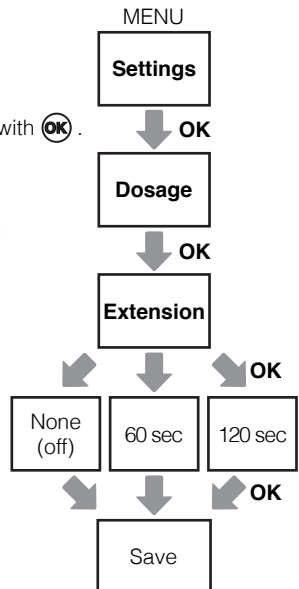
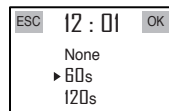
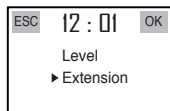
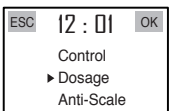

! NOTICE

When **Extension** is activated, the unit will extend ozone generation time after each usage to raise ozone concentration in advance for the next use.

Life Check

Step 1. Enter MENU and then select Life Check

- ▶ Press **MENU** .
- ▶ Use   to select **Life Check** and confirm with .

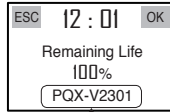
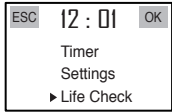

Product firmware Information

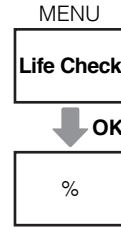

! NOTICE

The remaining life of cell cartridge is expressed in percentage (%). Information about the product firmware is provided as well.

3.4 SYSTEM CONFIGURATION GUIDES

Please contact your regional BioSure Professional dealer for further detail.

Applications	Control Setting
Water sanitation and waterlines treatment	Timer-Controlling or Flow-Starting
Commercial Faucet Integration, Commercial Laundry Integration	Flow-Starting

4.1 EXPECTED CELL CARTRIDGE LIFE

The life of cell cartridge is 1000 working hours*. Hard water or high mineral content water ($\text{CaCO}_3 > 250$ ppm) can shorten the cell's performance life. An alarm LED is present on the display panel of the device to warn that the cell cartridge is finished for its effective life cycle or an error is detected.

*Calculated on the basis of 2-3 hours usage (working hours) per day, the cell cartridge can be used for about 11-16 months. (The definition of working hours is actual ozone generating duration rather than the power-on time.)

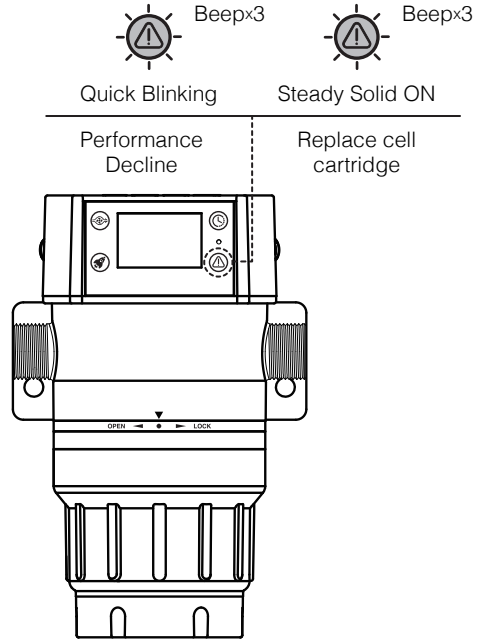

4.2 CELL CARTRIDGE REPLACEMENT

1. Unplug the device, open the faucet or tap closest downstream to the device.
2. Close the inlet water shut-off valve and allow the system to depressurize.
3. Disconnect the Cell Cartridge Power Plug from the Cell Cartridge Power Socket on the Head.
4. Hold body of device steady, untwist the used cartridge, pull to remove for replacement, and dispose of appropriately.

Step 1.

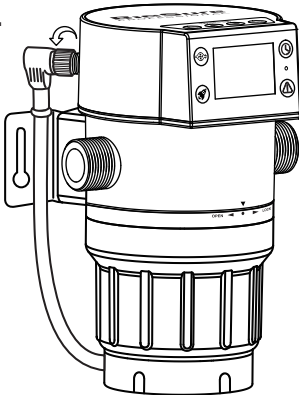

Step 2.

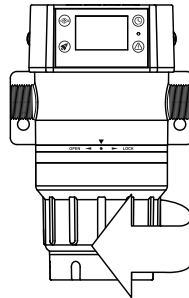

Step 3.

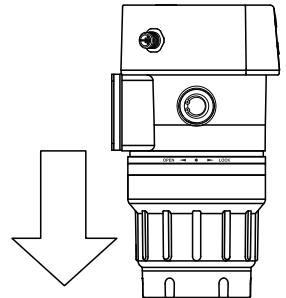

5. Revert the procedures with a new cartridge for replacement.

Step 1.

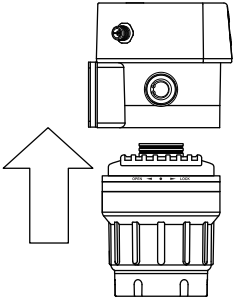

Step 2.

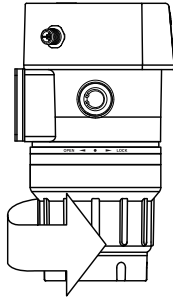

Step 3.

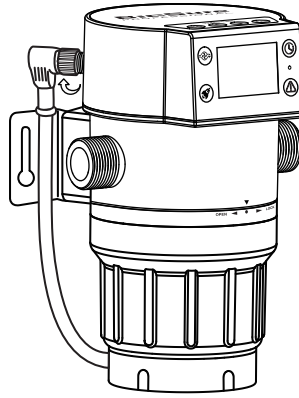

! NOTICE

Install or uninstall

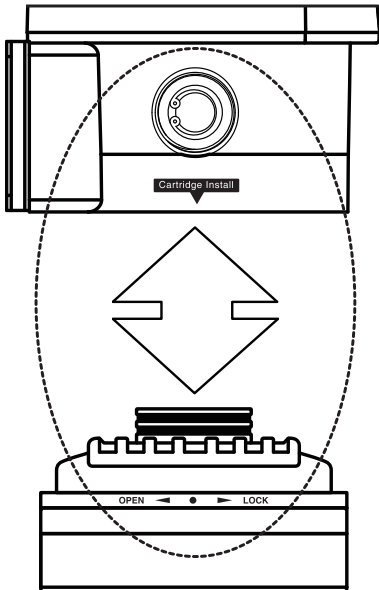

Lock-in position

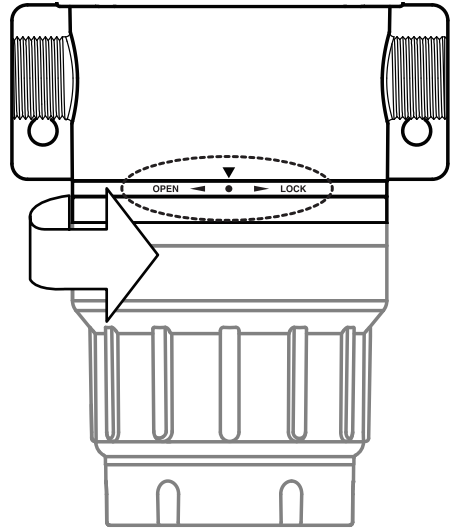

4.3 CELL CARTRIDGE CLEANING PROCEDURE

The cell cartridge of the unit will be affected by the water quality. Hard water can cause scaling, which could affect the operating capacity and life. The cleaning steps are as follows:

1. **Power off the unit.**
2. **Fill the cell cartridge with vinegar concentrate or white vinegar.**
Close the shut-off valve in front of the unit, detach the cartridge as described in section 4.2. Fill the cell cartridge with vinegar concentrate or white vinegar.
3. **Wait for 2-24 hours.**
The higher the vinegar concentration, the fewer hours is needed. It would takes about 2 hours for 20% vinegar concentrate or 24 hours for white vinegar.
4. **Pour out the vinegar and rinse the cartridge with clean tap water.**
Rinse the cartridge with clean tap water at least 3 times.
5. **Follow the instructions in section 4.2 to reinstall the cell cartridge and switch-on the shut-off valve to complete the cleaning procedures.**

! NOTICE

The scale cleaner can be made of 20-50% vinegar or 50% citric acid solution. It is better to use hot water for preparation, and be careful not to scald yourself during the mixing process.

After preparation, let it sit for a period of time according to the instructions of the scale cleaner (if the cleaning solution temperature is above 50°C, soak for at least 1 to 2 hours. If at room temperature, extend the soaking time).





5

TROUBLESHOOTING

Use the following guide to self-check your problems before requesting repairs. If you come into a conclusion that problem has occurred, do NOT attempt to disassemble and repair the product yourself, but contact BES Group or your dealer for support.

Sometimes suspected problem is remedied by disconnecting the power plug and then re-connecting it.

Problem	Possible Cause	Corrective Action
Unit does not have power. Light effects are absent.	The power cord is not correctly plugged in.	Plug the power cord in correctly.
	The power outlet is not working properly.	Correct the power outlet.
The Control Display is blank.	The power cord is not correctly plugged in.	Plug the power cord in correctly.
	Control panel is inoperable.	Contact your maintenance person or authorized service agency.
	Power Supply is inoperable.	
No water comes out of the unit.	Inlet shut-off valve closed.	Open the valve.
Water leaks from system fitting or connection.	Fitting broken or loose.	Retighten or replace the fitting.
	Not enough pipe thread sealant used.	Redo the fitting with proper amount of sealant.
<p>Alarm is ON</p>  <p>Slow blinking</p> <p>On-screen Display Error E01</p> <p>Sound (if activated): Beep x 3</p>	Timing system malfunction detected when turning on the unit.	Contact your maintenance person or authorized service agency.

Problem	Possible Cause	Corrective Action
<p>Alarm is ON</p>  Slow blinking	<p>Cell cartridge disconnection or connection failure detected when turning on the unit.</p>	<p>Reconnect the cell cartridge cable. If it does not work, please contact your maintenance person or authorized service agency.</p>
<p>Alarm is ON</p>  Slow blinking	<p>Cell cartridge malfunction.</p>	<p>Power off the unit and power it back on 10 sec later. If it does not work, please contact your maintenance person or authorized service agency.</p>
<p>Alarm is ON</p>  Slow blinking	<p>The model of cell cartridge replacement does not match (incorrect model of part is used).</p>	<p>Replace a correct cell cartridge. Contact your maintenance person or authorized service agency.</p>
<p>Alarm is ON</p>  Fast blinking	<p>Loose or defective contact of cell cartridge occurs during operation.</p>	<p>Reconnect the cell cartridge and restart the unit. If the symptom remains, contact your maintenance person or authorized service agency.</p>
	<p>TDS too low.</p> <p>Scaling in the cell cartridge due to mineral content in water (hardness).</p>	<p>Correct water source.</p> <p>Performance drop may be associated with scaling in the generator. Please excute the cleaning procedure in Section 4.3.</p>
<p>Alarm is ON</p>  Steady Solid ON	<p>Cell cartridge is due for replacement.</p>	<p>Replace a new cell cartridge immediately. Contact your maintenance person or authorized service agency.</p>

Please have the model number and serial number of the device available when calling for support.

LIMITED WARRANTY

Equipment manufactured by Biotek Environmental Science Ltd. has been constructed of the finest materials available and manufactured to high quality standards. When installed in accordance with manufacturer's recommendations, and under normal use and service, new BioSure Professional WDS or WDS3000X units are warranted to be free of defects due to poor materials or workmanship for the period of time listed below (following the date of purchase):

- WDS / WDS3000X Head & Connecting Body: 2 years.
- WDS / WDS3000X Cell Cartridge: 6 months or the end of life (whichever comes first).

Exclusions: This warranty does not cover failures due to improper system installation, defects caused by improper storage or handling prior to placing of the equipment into service. This warranty does not include damages due to attempted repairs or installation by unauthorized service agencies or personnel. This warranty does not cover normal maintenance, calibration, or regular adjustments as specified in operating and maintenance instructions of this manual, and/or labor involved in moving adjacent objects to gain access to the Equipment. Biotek Environmental Science Ltd. is not liable under this warranty for repairs or damages due to alterations, abuse, fire, flood, or acts of nature.

Additionally, this warranty may be voided in the case of:

- Failure to follow BES Group instructions for use, care, or maintenance.
- Removal, alteration, or defacing of BES Group-affixed serial number and other labels.
- Mechanical damage.
- Use of fluids other than clean, potable water.

This warranty is conditional upon Biotek Environmental Science Ltd. receiving notice of any defect subject to this warranty within thirty (30) days of its original discovery by the User/Buyer.

Biotek Environmental Science Ltd. reserves the right to make changes in design or add any improvements on any product. The right is always reserved to modify equipment due to factors beyond our control and continuous product development. Changes to update equipment do not constitute a warranty charge.

If shipment is damaged in transit, the purchaser should make a claim directly upon the carrier. Careful inspection should be made of the shipment as soon as it arrives and visible damage should be noted upon the carrier's documentation. Damage should be reported to the carrier. This damage is not covered under this warranty. Prices and specifications are subject to change without notice.



CONTACT INFORMATION

BES Group / Biotek Environmental Science Ltd.

info@besgroups.com

www.besgroups.com